

JOST

2024
women and men

NOS | WORKBOOK

NOS WORK BOOK

women and men

Über JOST

2002 ins Leben gerufen, setzt JOST mit seinen hochwertigen, vorwiegend in Europa produzierten Taschen, Börsen und Rucksäcken aus Europäischen Ledern und Geweben von Anfang an deutliche Zeichen und Trends im Fashion-Bereich. Die Wurzeln des Unternehmens reichen zurück bis ins Jahr 1891. Schon seit Gründung galt der Grundsatz: hochwertige Handarbeit, qualitativ herausragende Materialien und ein authentisch-eigenständiger Stil. Attribute, die in Kombination mit der reichen Erfahrung aus jahrzehntelanger Produktion zum nationalen als auch internationalen Erfolg beitragen. Heute zeichnen sich die mehrfach mit Design Awards prämierten JOST Taschen vor allem durch ihren typischen Charakter, ihre durchdachte Funktion und ihre hochwertige Verarbeitung aus.

Heute führen Josefine Jost und ihr Vater Dietmar Jost in der 5. Generation dieses Erbe weiter, mit dem gemeinsamen Ziel, dem Markt langlebige, funktionale Taschen zu präsentieren, die dem modischen Zeitgeist immer wieder neu entsprechen.

Über die Kollektion

Unsere NOS Kollektion für Damen und Herren folgt einer einfachen und klaren Systematik aus Modell, Material und Preis. Im Zentrum der Kollektion befinden sich zwei Key-Items: die wandelbare X-Change Bag für Damen, sowie der beliebte Roll-Top Backpack für Herren. Über alle Serien hinweg werden diese beiden Modelle mit erfolgreichen, verkäuflichen Rucksäcken, Umhängetaschen, Kurzgrifftaschen und Accessoires ergänzt.

Die verschiedenen Serien bestehen aus gleichen oder ähnlichen Modellen in einer Vielfalt von Materialien und Farben. Wir bieten hochwertige Leder, moderne Kunstleder und ausgefallene Gewebe-Materialien. Über diese Material- und Modellvarianz erreichen wir eine einmalige Breite im Preis.

Die Systematik, die unserer Kollektion zugrunde liegt, verbindet die unverwechselbare Designsprache und den hohen Wiedererkennungswert unserer Marke, mit einer breiten Verkäuflichkeit.

About JOST

Founded in 2002 by Dietmar Jost, JOST's premium backpacks, bags and wallets – made in Europe from European leathers and fabrics – have been setting directional trends and fashion statements from day one. JOST's roots date back to 1891. Over time, the company grew from a small saddlery into a strong and successful family-run enterprise. Its founding and enduring premise: high-end craftsmanship, exceptional materials and a unique, authentic style. Attributes that continue to drive the brand's national and international success, bolstered by decades of solid production experience. The current line-up of multiple awardwinning JOST bags excels with exceptional workmanship, a unique personality and clever functionality.

Today, Josefine Jost and her father Dietmar Jost are the 5th generation to carry on this legacy with the common goal of presenting the market with durable, functional bags that are always in tune with the fashionable zeitgeist.

About the collection

Our NOS collection for men and women follows a simple and clear system of model, material and price. At the center of the collection are two key items: the versatile X-Change Bag for women, and the popular Roll-Top Backpack for men. Across all series, these two items are complemented with successful, marketable backpacks, shoulder bags, short handle briefcases and accessories.

The different series consist of the same or similar models in a variety of materials and colors. We offer high quality leather, modern synthetic leather and sophisticated fabric materials. Through this variety of materials and models, we are able to achieve a unique width in price.

The systematic approach, on which we base our collection, combines the unmistakable design language and the strong recognition of our brand, with a broad marketability.

04 ACTIVE FUNCTION

Bags enabling the active, modern lifestyle - for a smooth transition from work to play

06 LILLEHAMMER

14 BILLUND CYCLIST PRO

20 LOHJA

26 BUSINESS FUNCTION

Elaborated down to the smallest detail: straightforward and contemporary business lines.

30 AARHUS

38 STOCKHOLM

50 MALMÖ

56 RIGA

62 TALLINN

70 ESSENTIALS

JOST essentials for women: functional in a modern northern style.

72 MESH

76 BERGEN

82 SMALL LEATHER GOODS

94 X-CHANGE BAG

96 INFO

96 LINE OVERVIEW

98 POS

99 SALES CONTACT

Production Team CREATIVE DIRECTION Josefine Jost, Dietmar Jost PHOTOGRAPHY & GRAPHIC DESIGN Studio Jonas Becker
ADDITIONAL PHOTOGRAPHY Ryan Allan, themoldermway VIDEOGRAPHY Johannes Schön MODELS Alina Stockl, Lisa Marie Anna, Maren Thelen,
Jonathan Claasen, Taka, Sean Justus HAIR & MAKE UP Adrienne Kremer, Monika Michalik, Frauke Bergemann-Gorski STYLING Josefine Jost, Nessi Akerdem,
Betti Bodor ORGANISATION Andrea Eberhardt, Andrea Schmitz, Marco Schrooten and the JOST Team

JOST

ACTIVE FUNCTION



**PRICE
RANGE**



**RECYCLED
LINING**



**CYCLIST FRIENDLY
FUNCTIONS**



UNISEX



**REFLECTIVE
DETAILS**



**TECHNICAL
FABRICS**

Taschen für einen aktiven, modernen Lebensstil - für einen geschmeidigen Übergang zwischen Arbeit und Freizeit. Alle Taschen basieren auf unseren funktionalen Grundmodellen, die durch clevere Features wie Fahrrad-Clip-On-Funktionen, Helmhalterungen und erweiterbare Taschen ergänzt werden. Nachhaltige technische Stoffe in glatten, ultramatten Oberflächen sorgen für ein modernes und angesagtes Statement.

Bags enabling the active, modern lifestyle - for a smooth transition from work to play. All bags are built on our functional base styles, topped with clever features such as bicycle clip on functions, helmet carriers and extendable pockets. Sustainable technical fabrics in sleek, ultra-matte surfaces serve a modern and hip statement.

JOST

line **LILLEHAMMER**



Our utmost sustainable line embraces today's dynamic lifestyle. Where work and play life close together LILLEHAMMER offers a strikingly casual statement with its 100% recycled crinkle nylon surface.

origin china
material 100% recycled nylon
 from post-industrial waste
colors 001 black, 002 olive
styles total 7

-  reflective details
 -  water repellent
 -  recycled lining
 -  extendable
- 

JOST



line **LILLEHAMMER**
FEATURES



100% Recycled nylon fabric made from post-industrial waste with a matte, crinkle finish and reflective trims.



helmet carrier

All bigger bags come with an extra net that can be attached to carry a helmet or jacket.



extendable pack

You can easily attach the orange pack for extra storage and maximized visibility.

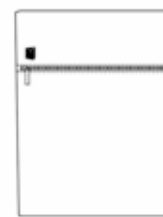

inside



inside

9488-001 Business Backpack Courier
31 x 44 x 15 cm / 10,9 l / [15"]
RRP 149,00 Euro



inside



inside

9487-001 Shoulder Bag Courier
38 x 30 x 10 cm / [15"]
RRP 129,00 €

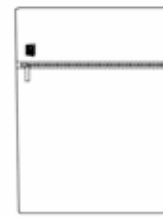

inside

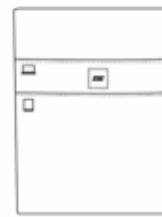

inside

9488-002 Business Backpack Courier
31 x 44 x 15 cm / 10,9 l / [15"]
RRP 149,00 Euro



inside



inside

9487-002 Shoulder Bag Courier
38 x 30 x 10 cm / [15"]
RRP 129,00 €

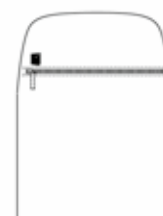

inside

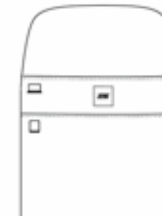

inside

9489-001 Daypack Backpack
32 x 44 x 14 cm / 10,3 l / [15"]
RRP 149,00 Euro



inside



inside

9486-001 Business Bag 1 Compartment
40 x 31 x 9 cm / [15"]
RRP 129,00 €



inside



inside

9485-001 Shoulder Bag Zip XS
21 x 18 x 6 cm
RRP 69,95 Euro



front

9491-001 Pouch
20,5 x 16 cm
RRP 24,95 Euro



9490-009 Case M
22,5 x 16 x 5 cm
RRP 24,95 Euro



front

9491-002 Pouch
20,5 x 16 cm
RRP 24,95 Euro





line **BILLUND CYCLIST PRO**

JOST



Vegan, water-repellent cotton fabric, rubberized PU, strong reflective trimmings and smart clip-on functions for bicycles. BILLUND CYCLIST PRO meets the high functional demands of modern commuters and bike enthusiasts

origin china
material coated cotton canvas and pu
colors 001 black
styles total 6

-  reflective details
-  vegan
-  water repellent
-  recycled lining
-  clip-on functions

line **BILLUND CYCLIST** FEATURES



clip-on function

The attachment clips are located on the back in a zip compartment under the heavily padded back panel.



Water-repellent, coated cotton fabric and rubberized PU paired with strong reflective trimmings.

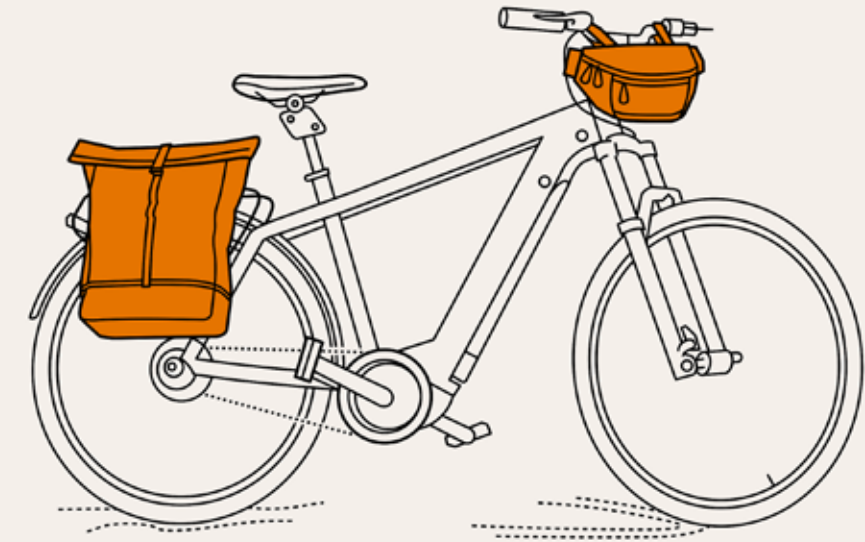

The attachment clips are located on the back in a zip compartment under the heavily padded back panel.

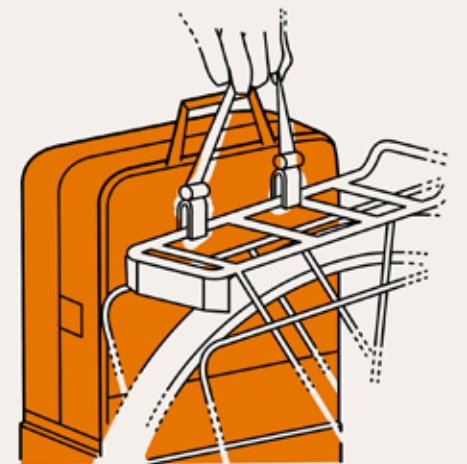

You can easily fasten your backpack or business bag on the bike rack by using the adjustment handle of the attachment clips.

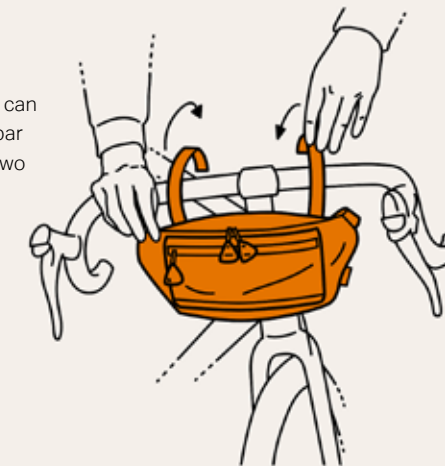

The popular crossover bag can be attached on the handlebar in no time with the help of two strong velcro straps.



4865-001 Backpack Courier
30 x 46 x 13 cm / 6,6 l / [15"] | RRP 169,00 €

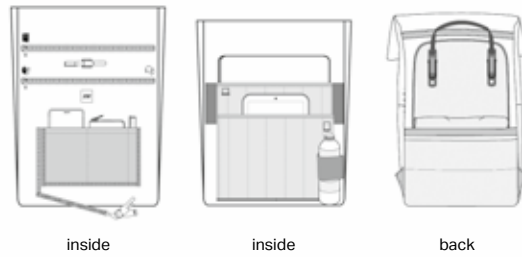

inside

inside

back



4866-001 Daypack Backpack
30 x 42 x 13 cm / 6,2 l / [15"] | RRP 169,00 €

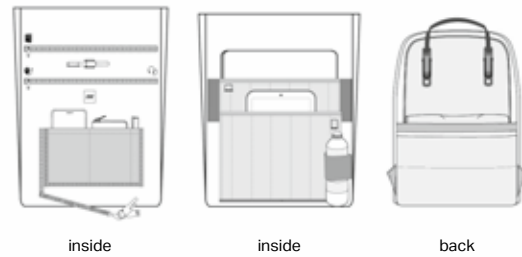

inside

inside

back



4859 Shoulder Bag Courier
38 x 30 x 10 cm / [15"] | RRP 169,00 €

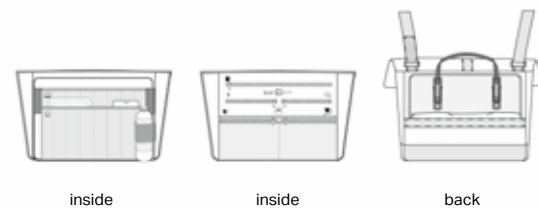

inside

inside

back



4860 Business Bag 1 Compartment
40 x 31 x 9 cm / [15"] | RRP 169,00 €



inside

inside

back



4864 Cross Over Bag
44 x 18 x 9 cm | RRP 69,95 €

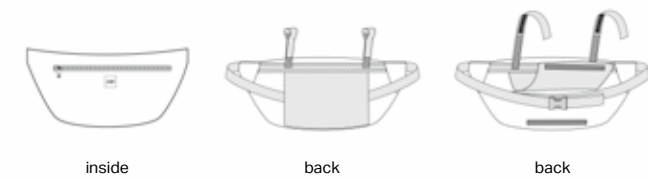

inside

back

back



4858 Shoulder Bag Zip XS
18 x 21 x 5 cm | RRP 69,95 €

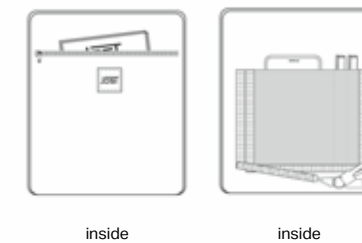

inside

inside

line **LOHJA**



Sportive, lightweight and highly technical fabrics delivered on reliable styles. LOHJA offers a modern, feminine approach to urban sportswear accessories.



origin china
material 100% taslan nylon, nylon taffetta
colors 001 black, 002 salvia
styles total 6

JOST



line **LOHJA**
FEATURES

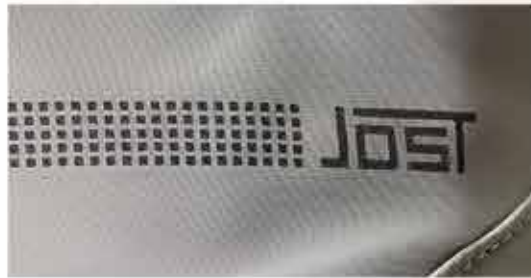

reflective details

modern, lightweight taslan nylon and nylon tafetta



All styles available in all-black (-001) fabric combination, paired with reflective details and striking orange strings.





9098-001 X-Change Bag S
30 x 40 x 11 cm / [15"]
RRP 129,00 Euro



9098-002 X-Change Bag S
40 x 30 x 11 cm / [15"]
RRP 129,00 Euro



9096-001 Backpack Courier
32 x 35 x 12 cm / [13"]
RRP 109,00 Euro



9096-002 Backpack Courier
32 x 35 x 12 cm / [13"]
RRP 109,00 Euro



9097-001 Daypack Backpack
27 x 37 x 14 cm / [13"]
RRP 119,00 Euro



9097-002 Daypack Backpack
27 x 37 x 14 cm / [13"]
RRP 119,00 Euro



9094-001 Hobo Bag
21,5 x 26 x 12 cm
RRP 89,95 Euro



9094-002 Hobo Bag
21,5 x 26 x 12 cm
RRP 89,95 Euro



9099-001 Shopper
33 - 44 x 42 x 15 cm
RRP 49,95 Euro



9099-002 Shopper
33 - 44 x 42 x 15 cm
RRP 49,95 Euro



9095-001 Hobo Shoulder Bag
32 x 23 x 10 cm
RRP 99,95 Euro



9095-002 Hobo Shoulder Bag
32 x 23 x 10 cm
RRP 99,95 Euro

BUSINESS FUNCTION



**PRICE
RANGE**



**RECYCLED
LINING**



**REFLECTIVE
DETAILS**



**HIGHLY
FUNCTIONAL**

Systematischer, ausgewogener und moderner können Sie Ihre Business Abteilung nicht gestalten. Die vier Serien in dieser Kategorie leben alle von der gleichen Produkt-DNA: hochfunktionale und maximal durchdachte Business-Artikel. Spannende Design-Details erlauben es Ihnen, Ihr Business-Regal endlich abzustauben, ohne dabei auf Funktion, Qualitätsanspruch und Understatement zu verzichten.

You could never shape your business segment in a more systematic, balanced and modern way. The four series in this category all live from the same product DNA: highly functional and maximally thought-out business articles. Exciting design details allow you to finally dust off your business shelf without sacrificing function, quality standards and understatement.

JOST

BUSINESS FUNCTION

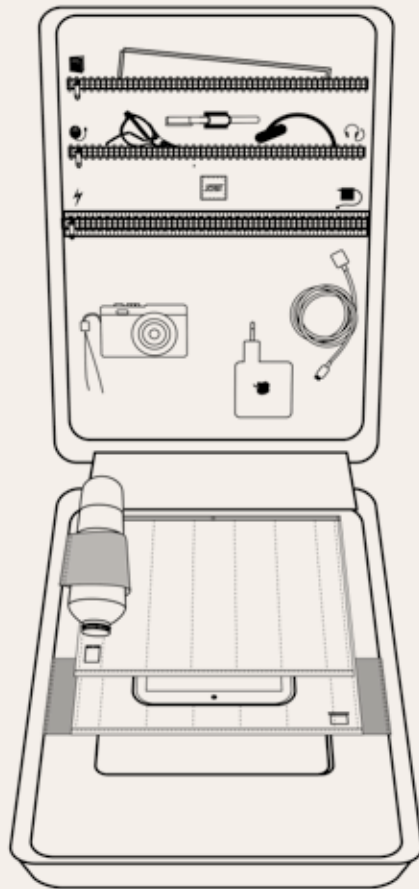

INNENLEBEN

Organisation ist alles! Alle Modelle aus unserer Business + Function Serie verfügen über eine flexibel nutzbare, klare Innenaufteilung. Von Laptop bis Getränketasche bleibt Ihr Inventar so immer geschützt und gut sortiert.

ERGONOMIE

Für den ultimativen Tragekomfort sind die Rückenteile und Schultergurte der Business + Function Serie weich gepolstert. Damit wird das Pendeln so angenehm wie möglich gemacht.

DESIGN

Form follows function: Das Design unserer Business + Function Linie ist minimalistisch, unaufgeregt, praktikabel – und gerade dadurch souverän und stilsicher.

LANGLEBIGKEIT

Hier kommen nur die besten Leder und besonders strapazierfähige Funktionsmaterialien zum Einsatz. Robust und langlebig – das ist nachhaltig!

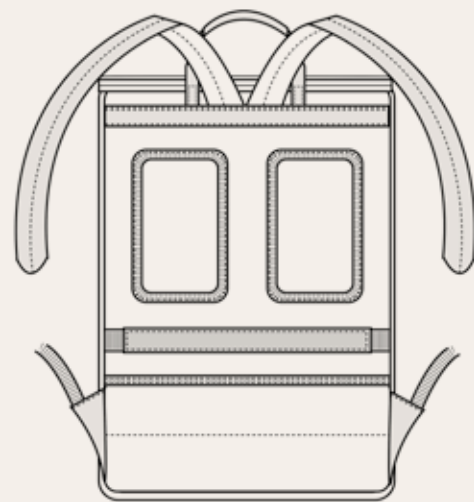

INTERIORS

Organization is key! All models from our Business + Function series are equipped with a flexibly adaptable, well-structured interior layout. From laptop to beverage compartment, your inventory will always be protected and well sorted.

ERGONOMICS

For the ultimate carrying comfort, the back panels and shoulder straps of the Business + Function series feature soft padding that will make your commute as smooth as possible.

DESIGN

Form follows function: the design of our Business + Function line is minimalistic, calm, practical - and just because of that confident and stylish.

DURABILITY

Only the best leathers and particularly strong functional materials are used here. Robust and durable - that's sustainable!

JOST

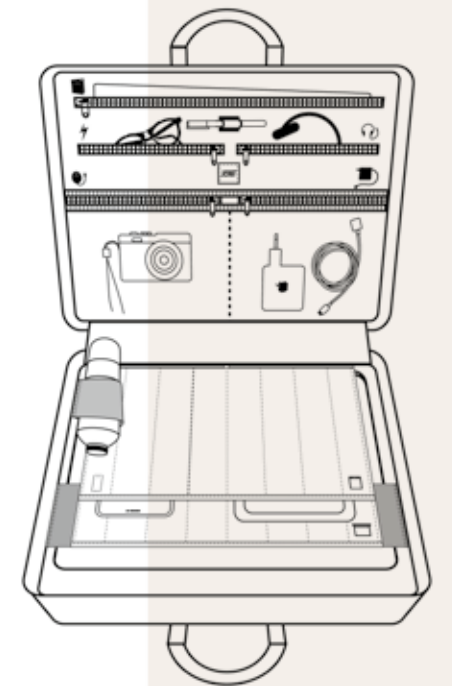

4692-001
Shoulder Bag L



4694-001
Business Bag

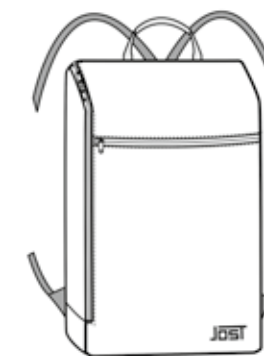

4700-001
Daypack Backpack



4697-001
Backpack Courier

BESTSELLER

line **AARHUS**



JOST



Inspired by timeless elegance, AARHUS offers a combination of high quality, functionality and sophisticated design, specially conceived for the modern business segment.

origin india
material nappa leather (LWG certified)
lining 100% recycled nylon
colors 001 black
styles total 11

-  water repellent
-  recycled lining
-  genuine leather
-  reflective zipper

line **AARHUS**

JOST



line **AARHUS**
FEATURES



Water-repellent, reflective zipper.



Soft nappa leather.



Soft nappa details.



9124 Backpack Courier
30 x 44 x 10 cm / 6,6 l / 15" | RRP 299,00 Euro

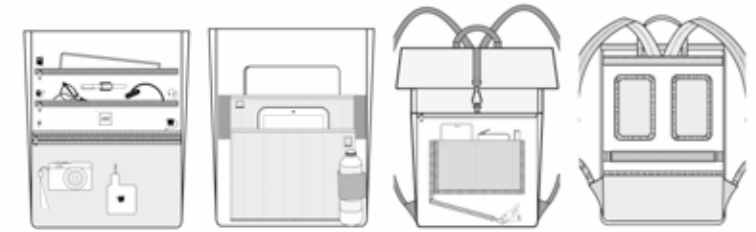

inside

inside

inside

back



9125 Daypack Backpack
31 x 42 x 10 cm / 6,6 l / 15" | RRP 299,00 Euro

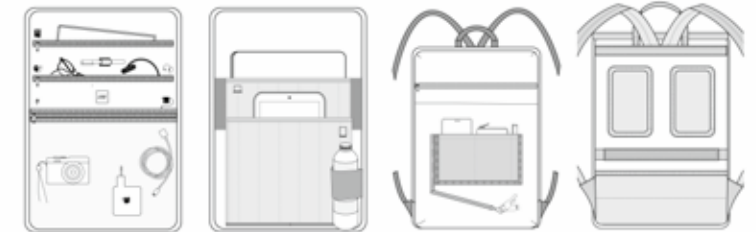

inside

inside

inside

back



9123 Business Bag 1 Comp.
40 x 30 x 10 cm / 15" | RRP 299,00 €

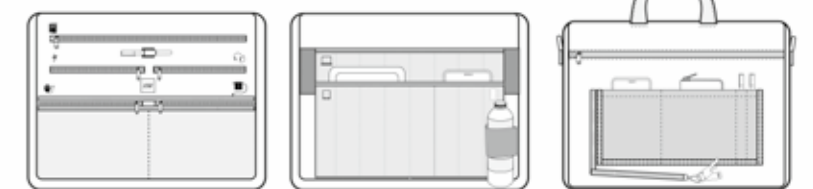

inside

inside

inside



9119 Shoulder Bag
20 x 24 x 9 cm | RRP 179,00 €

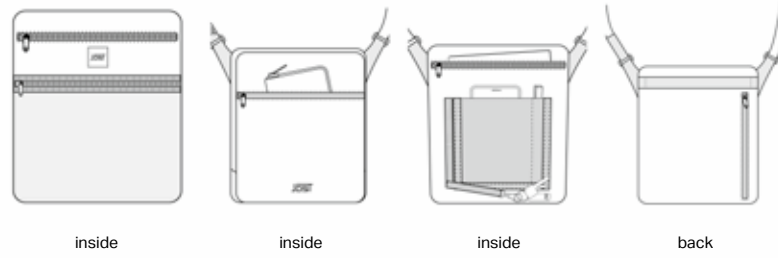

inside inside inside back



9139 Cable Case
17 x 24 x 3 cm | RRP 99,95 €



inside inside



9120 Crossover bag
36 x 14 x 7 cm | RRP 99,95 €



inside inside



9138 Case
20 x 11 x 8 cm | RRP 99,95 €



inside inside



9121 Shoulder Bag XS
18 x 21 x 5 cm | RRP 149,00 €

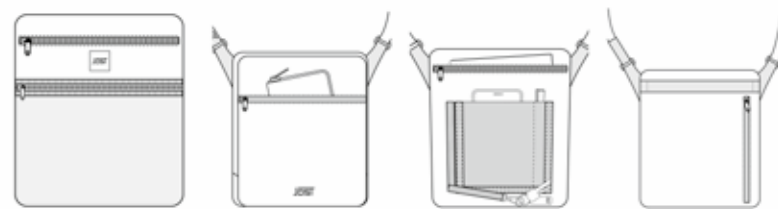

inside inside inside back



9127 Toilet Bag
21,5 x 11,5 x 11,5 cm | RRP 99,95 €



inside inside inside back



9122 Shoulder Bag L
38 x 30 x 10 cm / [15"] | RRP 299,00 €

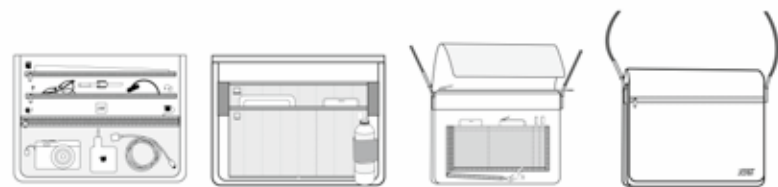

inside inside inside front



9126 Travel Bag
50 x 25 x 24 cm | RRP 399,00 €



inside back

line **STOCKHOLM**



STOCKHOLM delivers the classic business appeal on clean, functional, simplistic silhouettes without lacking innovation.

origin india
material leather
colors 001 black
styles total 18

-  reflective details
-  recycled lining
-  genuine leather

JUST



line **STOCKHOLM**

JOST



line **STOCKHOLM**
FEATURES



Water-repellent, reflective zipper.

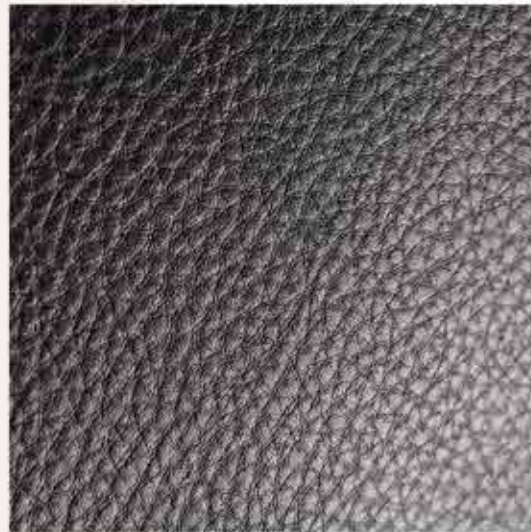

Full-grain pebbled cowhide leather with a solid stand and robust handfeel.



Soft nubuck details.



4697 Backpack Courier
30 x 44 x 10 cm / 6,6 l / [15"] | RRP 249,00 Euro

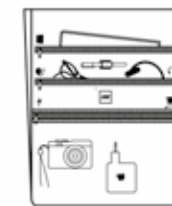

inside

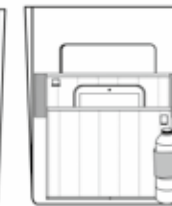

inside



inside



back



4698 Backpack Courier
30 x 44 x 10 cm / 6,6 l / [15"] | RRP 299,00 Euro

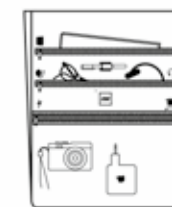

inside



inside

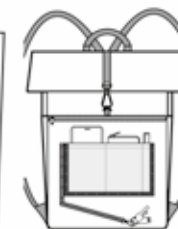

inside

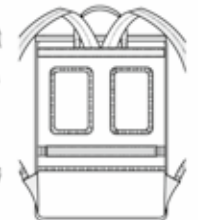

back



4700 Daypack Backpack
30 x 42 x 11 cm / 6,9 l / [15"] | RRP 279,00 Euro

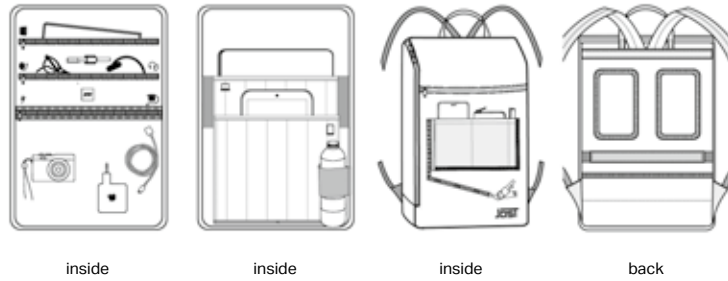

4699 Daypack Backpack
31 x 42 x 9,5 cm / 6,2 l / [15"] | RRP 279,00 Euro

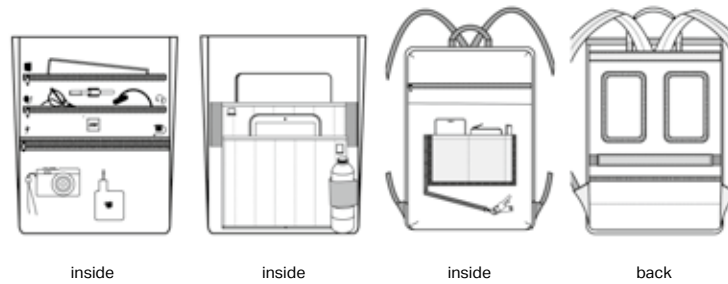

4693 Business Bag 1 Compartment Small
37 x 28 x 6 cm / [15"] | RRP 219,00 Euro



4694 Business Bag 1 Compartment
40 x 30 x 10 cm / [15"] | RRP 249,00 Euro

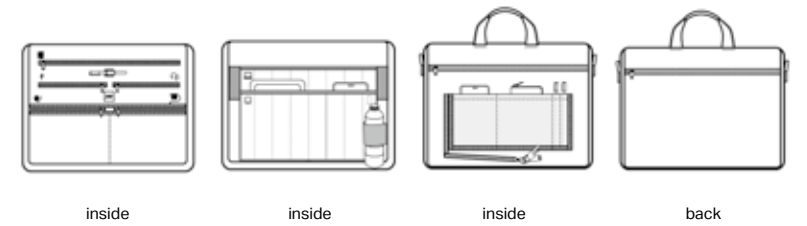

4695 Business Bag 2 Compartments
41 x 31 x 8 cm / [15"] | RRP 299,00 Euro

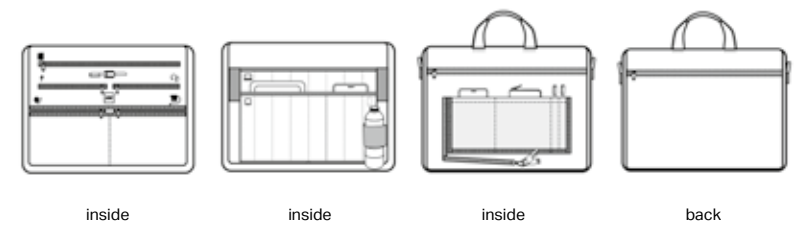



4686 Pouch
13 x 19 x 1,5 cm | RRP 89,95 Euro

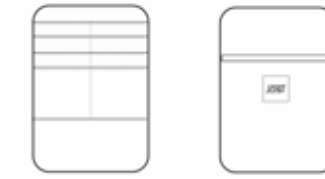

inside

front

4690 Shoulder Bag Flap S
23 x 26 x 6 cm / [10"] | RRP 179,00 Euro

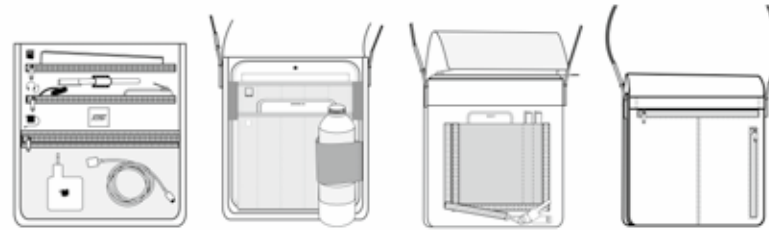

inside

inside

inside

back

4687 Men's Bag
20 x 13 x 6 cm | RRP 129,00 Euro



inside

inside

inside

back

4691 Shoulder Bag Flap M
32 x 26 x 8 cm / [10"] | RRP 229,00 Euro

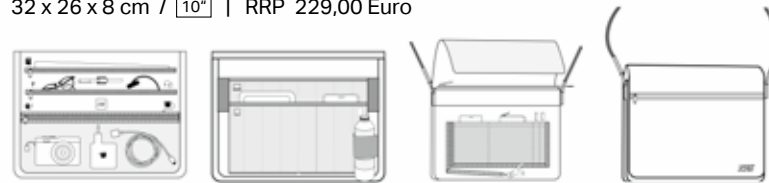

inside

inside

inside

front

4688 Shoulder Bag Zip XS
18 x 21 x 5 cm | RRP 129,00 Euro

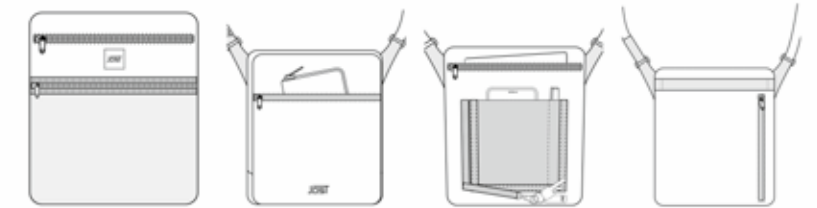

inside

inside

inside

back

4692 Shoulder Bag Flap L
38 x 30 x 10 cm / [15"] | RRP 249,00 Euro



inside

inside

inside

front

4689 Shoulder Bag Zip S
23 x 26 x 6 cm / [10"] | RRP 159,00 Euro

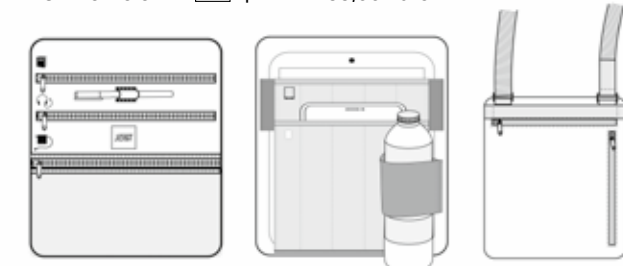

inside

inside

back

4685 Crossover Bag
36 x 14 x 7 cm | RRP 89,95 Euro

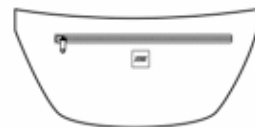

inside



back

4684 Crossover Bag
40 x 15 x 3 cm | RRP 129,00 Euro



inside



back

4701 Travel Bag
50 x 25 x 24 cm / 21,0 l | RRP 349,00 Euro



inside



back

4702 Toilet Bag
21,5 x 11,5 x 11,5 cm | RRP 99,95 Euro



inside



inside

line **MALMÖ**



Full-grain cowhide leather with a matte finish and black nubuk details. MALMÖ radiates a classic yet contemporary look.

origin india
material leather
colors 007 cognac
styles total 10

-  reflective details
-  recycled lining
-  genuine leather



JOST



line **MALMÖ**
FEATURES



Full-grain cowhide leather with a matte finish and black nubuck details.

Water-repellent, reflective zipper.



4506 Backpack Courier
30 x 44 x 10 cm / 6,6 l / [15"] / RRP 249,00 Euro

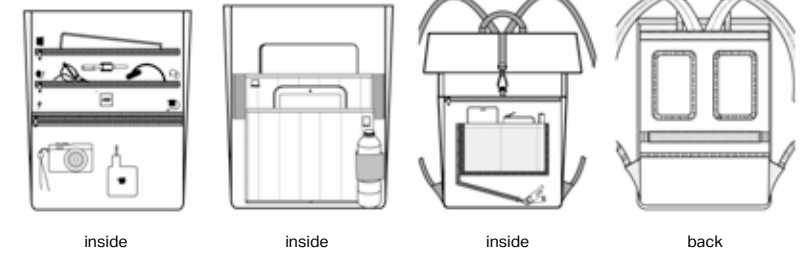

4507 Daypack Backpack
31 x 42 x 9,5 cm / 9,5 l / [15"] / RRP 279,00 Euro

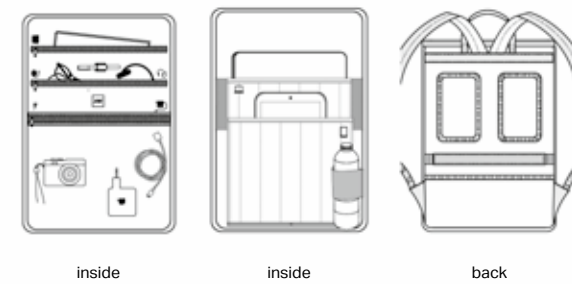



4505 Business Bag 1 Compartment
40 x 30 x 10 cm / [15"] | RRP 249,00 Euro

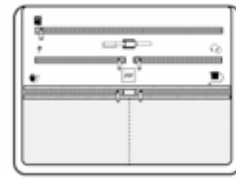

inside

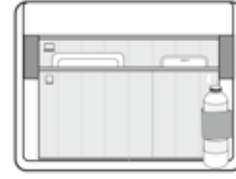

inside



inside



4501 Pouch
13 x 18 x 2 cm | RRP 89,95 Euro



inside



inside



4504 Shoulder Bag Flap L
38 x 30 x 10 cm / [15"] | RRP 279,00 Euro

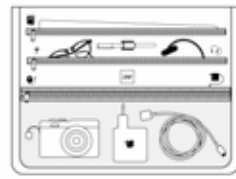

inside

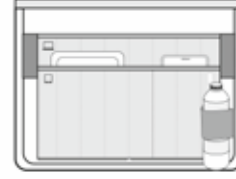

inside



inside



4500 Crossover Bag
36 x 14 x 7 cm | RRP 89,95 Euro



inside



4502 Men's Bag
20 x 13 x 6 cm | RRP 129,00 Euro



inside



inside



inside



back



4509 Toilet Bag
22 x 12 x 12 cm | RRP 99,95 Euro



inside



inside



4503 Shoulder Bag Zip XS
18 x 21 x 5 cm | RRP 129,00 Euro



inside

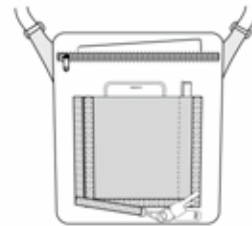

inside

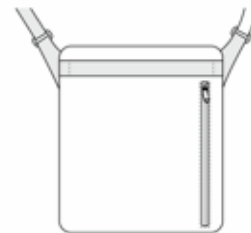

back



4508 Travel Bag
50 x 25 x 24 cm / 21l | RRP 349,00 Euro



inside



back

line **RIGA**



RIGA is made from high class vegan leather. This robust, yet light companions are ideal to complete a modern business look.

origin china
material vegan leather PU
colors 001 black
styles total 10

-  reflective details
-  recycled lining
-  vegan

JUST



line **RIGA**
FEATURES



High class vegan leather with a natural grain and reflective zips.



Black, silicone logo.



Water-repellent, reflective zipper.



3760 Backpack Courier
30 x 44 x 10 cm / [15"] | RRP 149,00 Euro

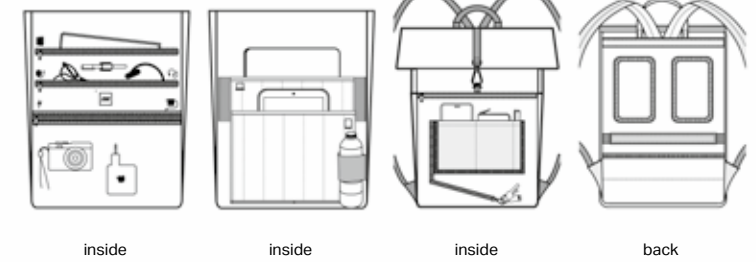

inside

inside

inside

back



3757 Daypack Backpack
30 x 42 x 13 cm / [15"] | RRP 149,00 Euro

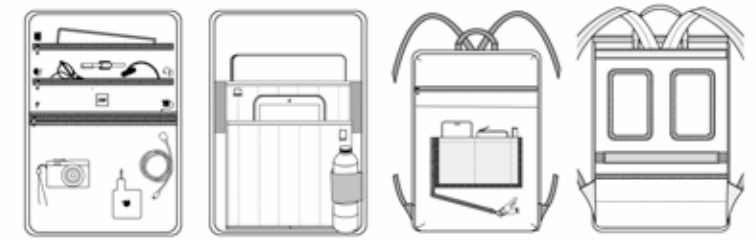

inside

inside

inside

back



3756 Business Bag 1 Compartment
40 x 30 x 10 cm / 15" | RRP 149,00 Euro

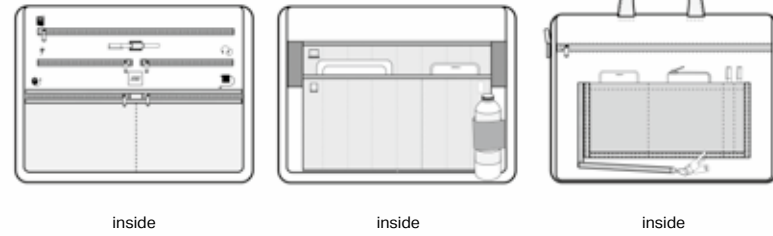

3753 Crossover Bag
13 x 18 x 2 cm | RRP 59,95 Euro

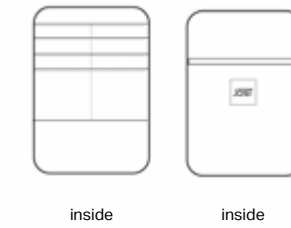

3759 Shoulder Bag Flap L
38 x 30 x 10 cm / 15" | RRP 149,00 Euro

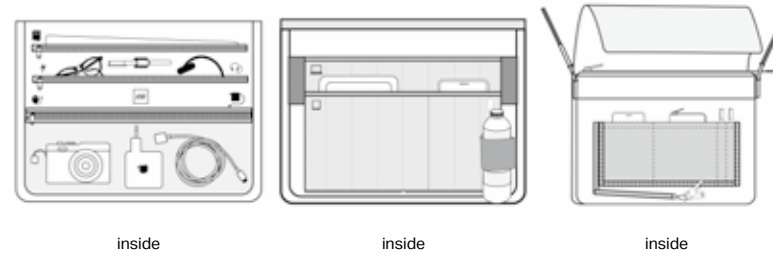

3758 Crossover Bag
38 x 15 x 6 cm | RRP 59,95 Euro



3754 Men's Bag
20 x 13 x 2 + 3,5 + 1 cm | RRP 69,95 Euro



3761 Toilet Bag
22 x 12 x 12 cm | RRP 69,95 Euro

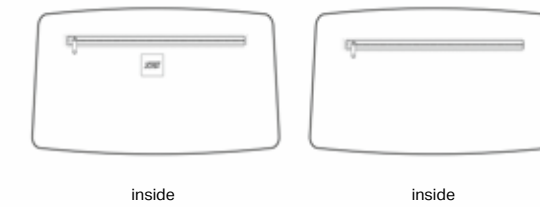

3755 Shoulder Bag Zip XS
18 x 21 x 5 cm | RRP 79,95 Euro

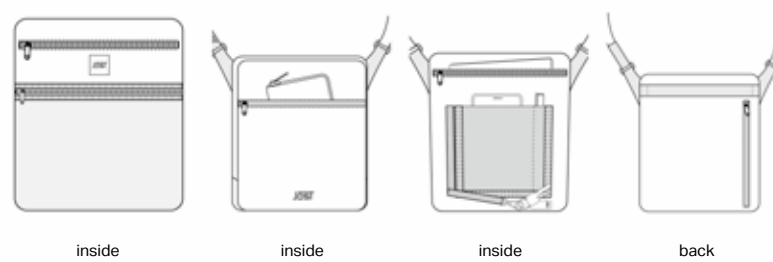

3762 Travel Bag
50 x 25 x 24 cm / 21,0 l | RRP 149,00 Euro

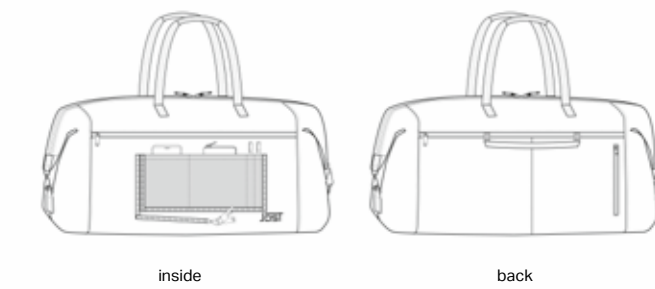

line **TALLINN**



The durable, water-repellent fabric in a contemporary matte finish of TALLINN creates perfectly lightweight business accessories for everyday use.

origin china
material 900D nylon, rubberized PU
colors 001 black
styles total 10

-  reflective details
-  recycled lining
-  vegan
-  water repellent

JOST



line **TALLINN**



JOST

line **TALLINN**
FEATURES



Sleek, waterrepellent 900D polyester with reflective zips and black silicone details.



3565 Backpack Courier
30 x 44 x 10 cm / 6,6 l / [15"] | RRP 149,00 Euro

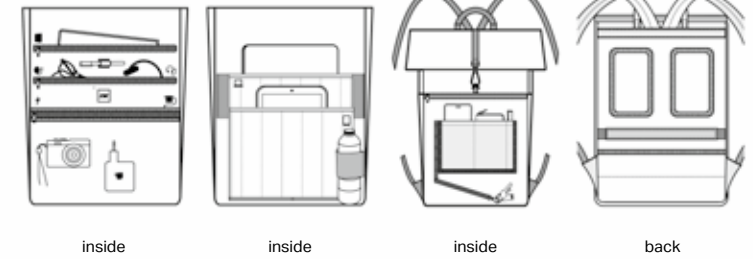

3562 Daypack Backpack
30 x 42 x 13 cm / [15"] | RRP 149,00 Euro

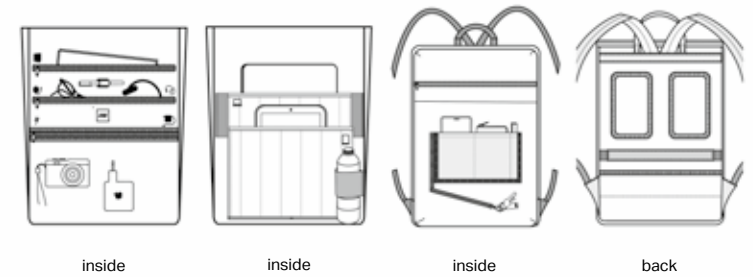



3561 Business Bag 1 Compartment
40 x 30 x 10 cm / 15" | RRP 149,00 Euro

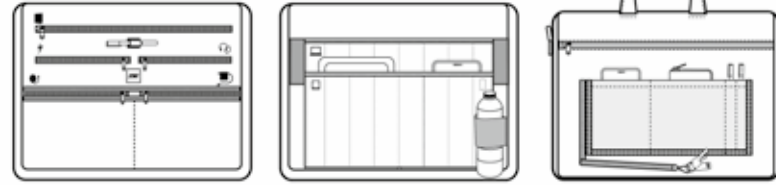

inside inside inside



3558 Pouch
13 x 18 x 2 cm | RRP 59,95 Euro



inside inside



3564 Shoulder Bag Flap L
38 x 30 x 11 cm / 15" | RRP 149,00 Euro

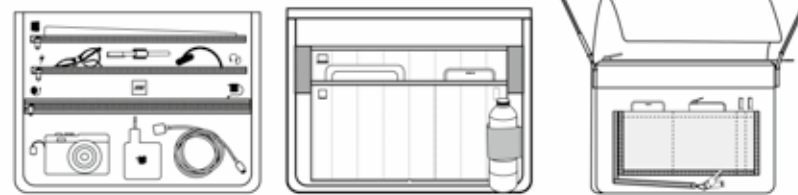

inside inside inside



3563 Crossover Bag
38 x 15 x 6 cm | RRP 59,95 Euro



inside back



3559 Men's Bag
20 x 13 x 2 + 3,5 + 1 cm | RRP 69,95 Euro



inside inside inside inside



3566 Toilet Bag
22 x 12 x 12 cm | RRP 69,95 Euro



inside back



3560 Shoulder Bag Zip XS
18 x 21 x 5 cm | RRP 79,95 Euro

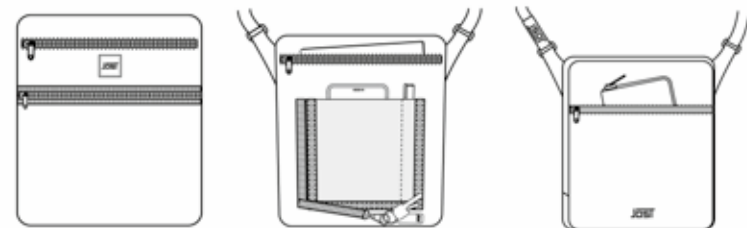

inside inside front



3567 Travel Bag
50 x 25 x 24 cm / 21,01 | RRP 149,00 Euro



inside back

JOST ESSENTIALS



**PRICE
RANGE**



**RECYCLED
LINING**



**JOST
BESTSELLER**

Die Serien dieser Kategorie bilden den kommerziellen, erfolgreichen Unterbau unserer Kollektion. Hier finden Sie unter Anderem unsere unverwechselbare X-Change Bag in spannenden Materialien und interessanten Preislagen. Mit diesen verlässlichen Topsellern liefern Sie den authentischen JOST Stil mit Leichtigkeit an Ihre Kunden.

The lines in this category form the commercially successful underpinnings of our collection. Here you will find, among others, our distinctive X-Change Bag in exciting materials and interesting price ranges. With these reliable top sellers you deliver the authentic JOST style to your customers with ease.

JOST



line MESH

JOST



The super sporty MESH series brings a whole new lightness to the cityscape with its exciting material mix of flexible, innovative 3D spacer mesh and leather details.

origin europe
material polyester mesh and leather
colors 008 silver
styles total 2

-  recycled lining
-  genuine leather
-  made in europe

line **MESH**
FEATURES



Durable metal fittings.



High quality mesh made of light polyester with full grain cowhide leather trimming.



6177 X-Change Bag XS
26 x 32 x 10 cm / 4,2 l
RRP 189,00 Euro



6178 X-Change Bag S
30 x 40 x 12 cm / 7,2 l / [15"]
RRP 219,00 Euro

line **BERGEN**



The vegan classic: BERGEN. Clear cuts, in lightweight water-repellent polyester, the ideal companion for everyday requirements.



origin china
material 600D polyester
colors 001 black, 006 navy, 008 grey,
 018 taupe, 028 light grey
styles total 9



JOST



line **BERGEN**
DETAILS



006 blue



018 taupe



008 dark grey



028 light grey



001 black

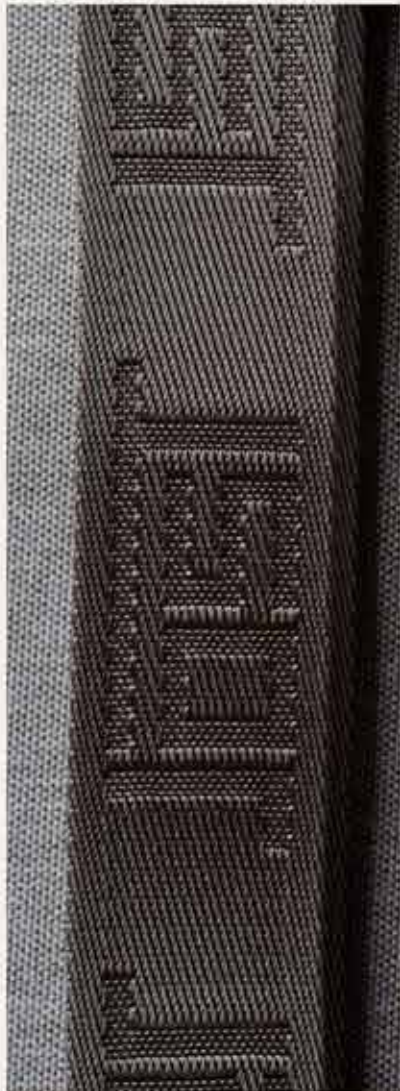

Durable metal fittings.

Made of a light polyester fabric with a waterrepellent surface.

JOST





1102-028 Crossover Bag
30 x 14 x 7 cm
RRP 59,95 Euro



1126-028 X-Change Bag XS
26 x 32 x 10 cm / 4,2l
RRP 119,00 Euro



1103-028 2-Way-Bag
23 x 34 x 11 cm
RRP 109,00 Euro



1134-028 Crossover Bag
20 x 30 x 7 cm
RRP 119,00 Euro



1099-028 Pouch
12 x 16 x 4 cm
RRP 79,95 Euro



1127-028 X-Change Bag S
30 x 40 x 12 cm / 7,2l / [15"]
RRP 139,00 Euro



1144-028 Backpack Courier
26 x 35 x 10 cm / 4,6l / [13"]
RRP 129,00 Euro



1135-028 Shoulder Bag
25 x 21 x 14 cm
RRP 99,95 Euro



1110-028 Shoulder Bag
25 x 14 x 9 cm
RRP 69,95 Euro

SMALL LEATHER GOODS

JOST



line **MALMÖ**



line **STOCKHOLM**

 genuine leather



line **AARHUS**



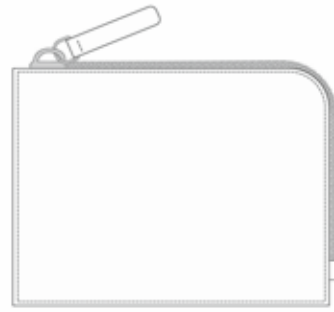

back

9137 Wallet
11 x 9,5 cm
RRP 29,95 €

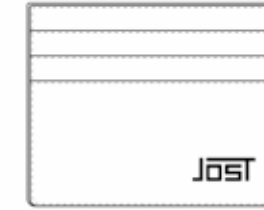

front

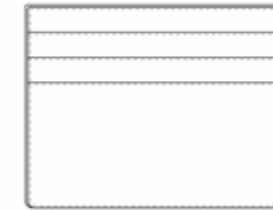

back

9130 Card Case
10 x 8 cm
RRP 19,95 €

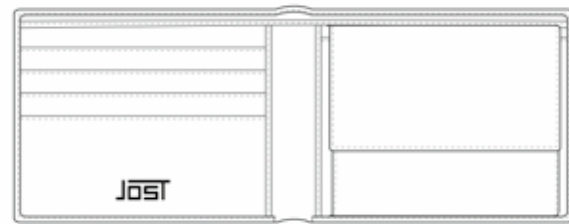

inside

9134 Wallet
10,5 x 7,5 cm
RRP 49,95 €

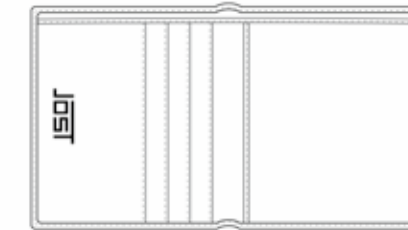

inside

9136 Wallet
8,5 x 10,5 cm
RRP 49,95 €



front

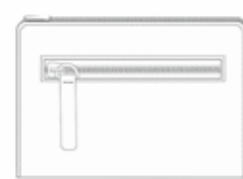

back

9132 Key Case
10 x 7 x 2 cm
RRP 29,95 €

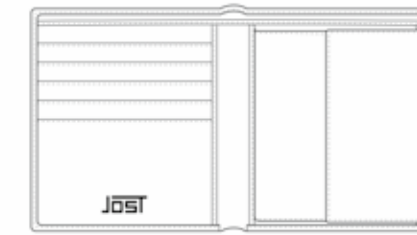

inside

9131 Wallet
12 x 10 cm
RRP 59,95 €



back

9133 Pencil Case
20 x 6 x 5 cm
RRP 39,95 €

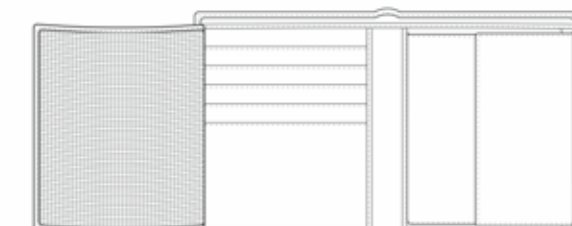

inside

9135 Wallet
10 x 12,5 cm
RRP 59,95 €

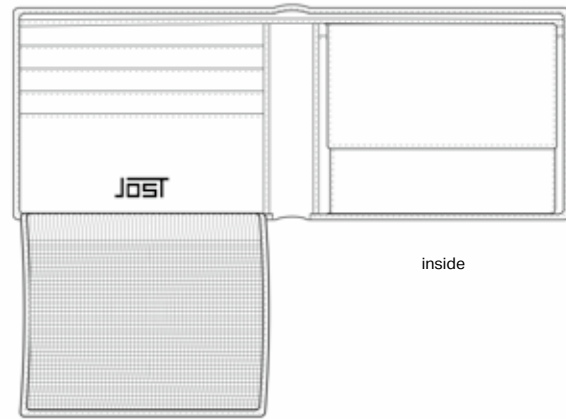

4727 Purse Wallet
10 x 8 cm
RRP 39,95 Euro

inside



4720 Card Holder
10 x 8 cm
RRP 14,95 Euro

front

back

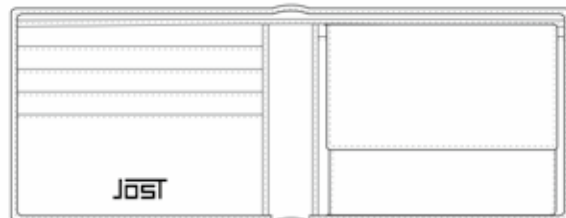

4728 Purse Wallet
10,5 x 7,5 cm
RRP 39,95 Euro

inside

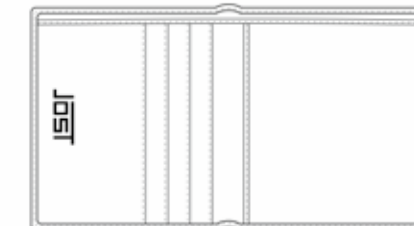

4731 Purse Wallet
8,5 x 10,5 cm
RRP 29,95 Euro

inside

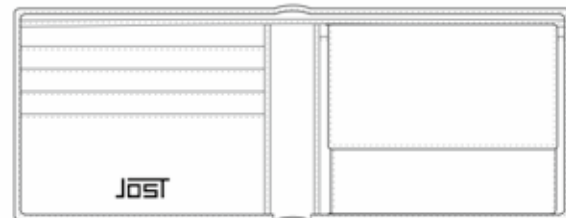

4729 Purse Wallet
12,5 x 10 cm
RRP 39,95 Euro

inside



4732 Purse Wallet
10,5 x 12,5 cm
RRP 39,95 Euro

inside

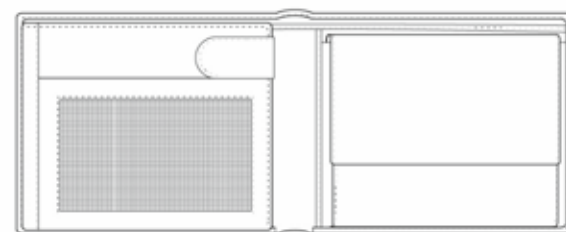

4730 Purse Wallet
12 x 10 cm
RRP 49,95 Euro

inside

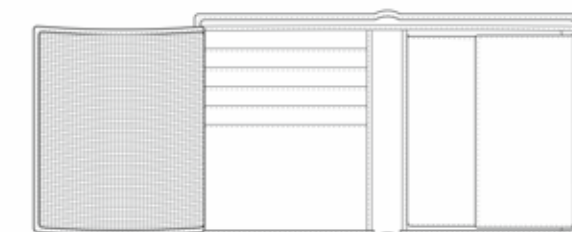

4733 Purse Wallet
10 x 12,5 cm
RRP 49,95 Euro

inside



front

4723 Card Holder
9 x 10,5 cm
RRP 29,95 Euro



inside



back

4725 Wallet Zip S
11 x 9,5 cm
RRP 29,95 Euro



front

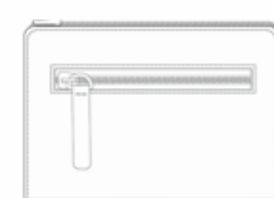

back

4726 Key Case
11 x 7,5 cm
RRP 29,95 Euro



back

4724 Wallet Zip
12 x 9 cm
RRP 39,95 Euro



back

4722 Card Holder
13 x 17 cm
RRP 24,95 Euro



front

back

4515 Card Holder
10 x 8 cm
RRP 14,95 Euro



front

4517 Card Holder
9 x 10,5 cm
RRP 29,95 Euro



back

4518 Card Zip S
12 x 9,0 cm
RRP 39,95 Euro

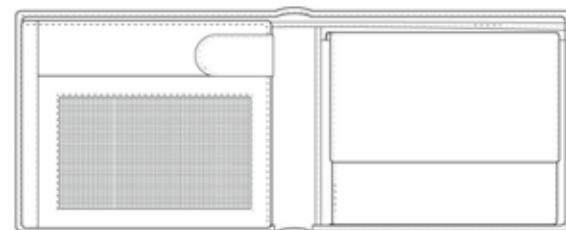

inside

4521 Purse Wallet
12 x 10 cm
RRP 49,95 Euro



front

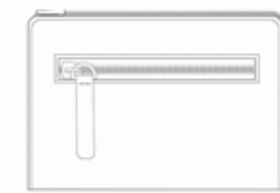

back

4520 Key Case
11 x 7,5 cm
RRP 29,95 Euro

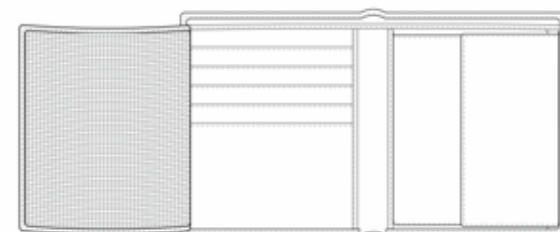

inside

4522 Purse Wallet
9,5 x 12 cm
RRP 49,95 Euro

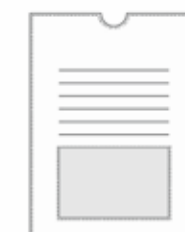

back

4519 Card Holder
13 x 17 cm
RRP 24,95 Euro

X-CHANGE BAG

HOW TO WEAR X-CHANGE BAG

JOSEPH



The new range revolves around the X-Change Bag. What makes this unisex shopper so special? The X-Change Bag can be carried by the handle, worn as a backpack or over the shoulder using the detachable strap.



Different Sizes – from XS and S – as well as different colour schemes offer our customers a great selection. Materials range from European leather to felt and fabric.



AVAILABLE IN 2 SIZES

S 30 x 40 x 12 cm **XS** 26 x 32 x 10 cm



LINE OVERVIEW

JUST

ACTIVE
FUNCTION



LILLEHAMMER

PRICE RANGE (RRP) 24,95 – 149,00 €

BODY 100% recycled Nylon from post-industrial waste. **LINING** 100% recycled Polyester. **ZIPPER** nylon, No 5, reflective zippers. **WEBBING** 74% polyester/ viscose/ 26% polypropylene. **METAL FITTING** zinc alloy, matt black. **COUNTRY OF ORIGIN** China. **COLOURS AVAILABLE** 001 black, 002 olive.



BILLLUND CYCLIST PRO

PRICE RANGE (RRP) 69,95 – 169,00 €

BODY 100% cotton, PU coated, and artificial leather PU. **TRIMMING** artificial leather, 100% PU. **LINING** 100% recycled Polyester. **ZIPPER** nylon, No 5, reflective zippers. **WEBBING** 74% polyester/viscose / 26% polypropylene. **METAL FITTING** zinc alloy, matt black. **COUNTRY OF ORIGIN** China. **COLOURS AVAILABLE** 001 black.



LOHJA

PRICE RANGE (RRP) 49,95 – 129,00 €

BODY 100% taslan nylon, nylon taffetta. **LINING** 100% recycled Polyester, 150D. **ZIPPER** Nylon, No 5. **WEBBING** 100% Polyester. **METAL FITTING** zinc alloy, brush nickel, black gun metal. **COUNTRY OF ORIGIN** China. **COLOURS AVAILABLE** 001 black, 002 salvia.



AARHUS

PRICE RANGE (RRP) 99,95 – 399,00 €

BODY nappa leather (LVG certified). **LINING** 100% recycled nylon. **ZIPPER** nylon, No 5, reflective zippers. **WEBBING** 74% polyester/ viscose / 26% polypropylene. **METAL FITTING** zinc alloy, matt black. **COUNTRY OF ORIGIN** India. **COLOURS AVAILABLE** 001 black.



STOCKHOLM

PRICE RANGE (RRP) 89,95 – 349,00 €

BODY full grain cowhide leather, chrome tannage, pre embossed and milled / 100% Polyester 168D with PU coating. **LINING** 100% recycled polyester, laptop compartment man made suede. **ZIPPER** nylon, No 5, reflective zippers. **WEBBING** 74% polyester/viscose / 26% polypropylene. **METAL FITTING** zinc alloy, matt black. **COUNTRY OF ORIGIN** India. **COLOURS AVAILABLE** 001 black.



MALMÖ

PRICE RANGE (RRP) 89,95 – 349,00 €

BODY full grain cowhide leather, chrome tanning, aniline dyeing, grain printed / 100% Polyester 168D with PU coating. **LINING** 100% recycled Polyester. **ZIPPER** nylon, No 5, reflective zippers. **WEBBING** 74% polyester/viscose / 26% polypropylene. **COUNTRY OF ORIGIN** India. **COLOURS AVAILABLE** 007 cognac.



RIGA

PRICE RANGE (RRP) 59,95 – 149,00 €

BODY artificial leather, 100% PU / 100% Polyester 168D with PU coating. **TRIMMING** artificial leather, 100% PU. **LINING** 100% recycled Polyester, laptop compartment man made suede. **ZIPPER** nylon, No 5, reflective zippers. **WEBBING** 74% polyester/viscose / 26% polypropylene. **METAL FITTING** zinc alloy, matt black. **COUNTRY OF ORIGIN** China. **COLOURS AVAILABLE** 001 black.



TALLINN

PRICE RANGE (RRP) 59,95 – 149,00 €

BODY 100% polyester, 900D, PU coating and backing. **TRIMMING** artificial leather, 100% PU. **LINING** 100% recycled Polyester, laptop compartment man made suede. **ZIPPER** nylon, No 5, reflective zippers. **WEBBING** 74% polyester/viscose / 26% polypropylene. **METAL FITTING** zinc alloy, matt black. **COUNTRY OF ORIGIN** China. **COLOURS AVAILABLE** 001 black.



BERGEN

PRICE RANGE (RRP) 59,95 – 139,00 €

BODY 100% polyester, 600D, PU backing, water repellent. Trimming artificial leather, 100% PU. **LINING** 100% recycled Polyester, 150D. **ZIPPER** nylon, No 5. **WEBBING** 100% polyester. **METAL FITTING** zinc alloy, brush nickel. **COUNTRY OF ORIGIN** China. **COLOURS AVAILABLE** 001 black, 006 blue, 008 dark grey, 018 taupe, 028 light grey.



MESH

PRICE RANGE (RRP) 189,00 – 219,00 €

BODY fabric, 100% polyester, backing 100% cotton. **TRIMMING** full grain leather, cowhide, tanning semi chrome, dyeing semi chrome, natural grain light brushed. **LINING** 100% recycled Polyester, 150D. **ZIPPER** nylon, No 5. **WEBBING** 100% Polyester. **METAL FITTING** zinc alloy, brush nickel. **COUNTRY OF ORIGIN** Europe. **COLOURS AVAILABLE** 008 silver.



BUSINESS
FUNCTION

ESSENTIALS

POINT OF SALE

functional displays and logos



B71-0039-901 Logo Block
20 x 10,5 x 2,5 cm











B71-0047-904 Base Element
100 x 155 (85+70) x 40 cm

A3 Displays

- B71-0052-123 Display NOS LILLEHAMMER
- B71-0053-123 Display NOS BILLUND CYCLIST PRO
- B71-0054-123 Display NOS LOHJA
- B71-0055-123 Display NOS STOCKHOLM
- B71-0056-123 Display NOS MALMÖ
- B71-0057-123 Display NOS RIGA
- B71-0058-123 Display NOS TALLINN
- B71-0059-123 Display NOS BERGEN



ICONS

-  **REFLECTIVE DETAILS**
Reflective parts for high-visibility
 -  **RECYCLED LINING**
Lining is made from recycled PET bottles
 -  **CLIP-ON FUNCTIONS**
Easily attachable to your bike
 -  **WATER REPELLENT**
Water beads on the upper material
 -  **EXTENDABLE**
Additional bags can be connected
 -  **VEGAN**
Made of vegan materials
 -  **GENUINE LEATHER**
Upper material is high quality leather
 -  **MADE IN EUROPE**
 -  **Global Recycled Standard**
- Y"** Bag has a compartment for a Y"-sized device **A4** Bag fits a A4-sized paper

SALES CONTACT

Head of Sales
Felix Lieser
+49 151 11 58 68 36
felix.lieser@jost-bags.com

Netherlands
Valoroso Agenturen
Koen Simons
+31 61920 9575
koen@valoroso.nl
www.valoroso.nl

Denmark • Sweden • Norway • Finland
Bastion ApS, Lars Chalmer
+45 21 27 90 89
lc@bastion.dk
www.bastion.dk

Australia
JOST · c/o Keoma Pty Ltd
Marcel Goerke
+61 3 9948 7878
info@keoma.com.au

all other countries and Backoffice
Marco Schrooten
+49 2662 9513-0
marco.schrooten@jost-bags.com

  /jostbags

www.jost-bags.com

JOST

Copyright © 2024 Jost GmbH, all rights reserved.